

CX80

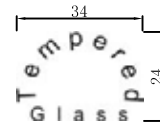

(770-790) * (770-790) * 1850

CX90

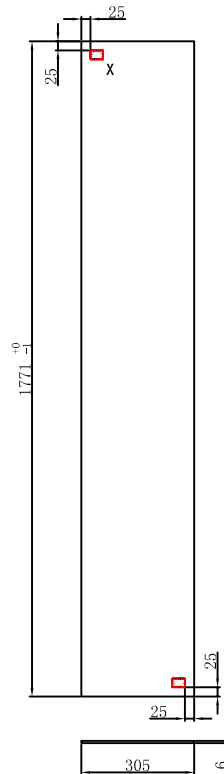
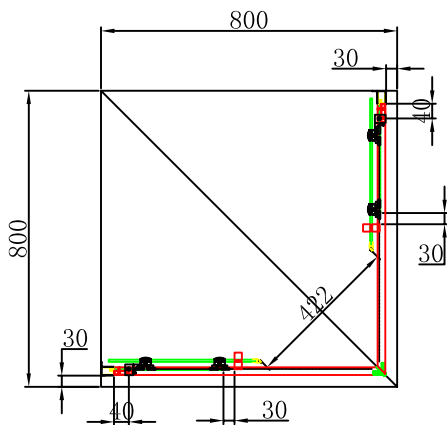
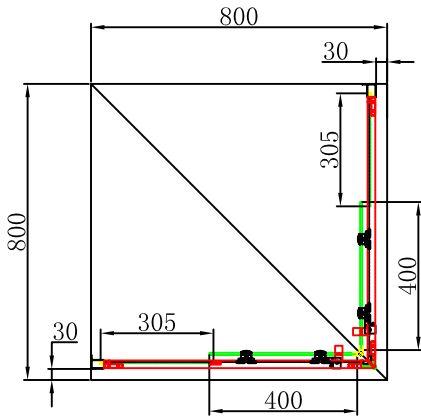
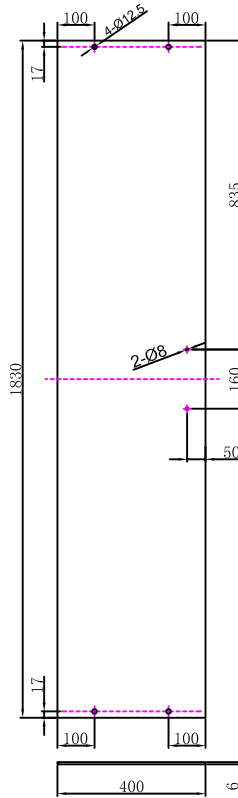
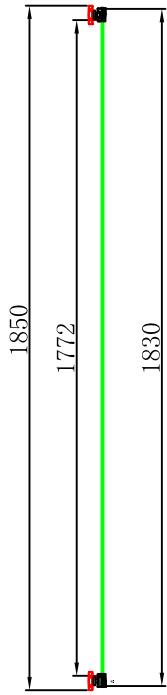
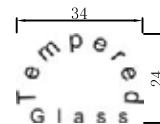
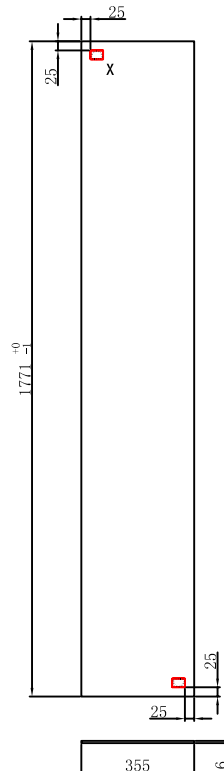
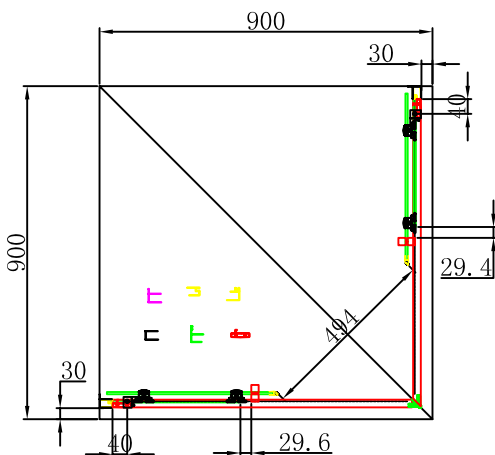
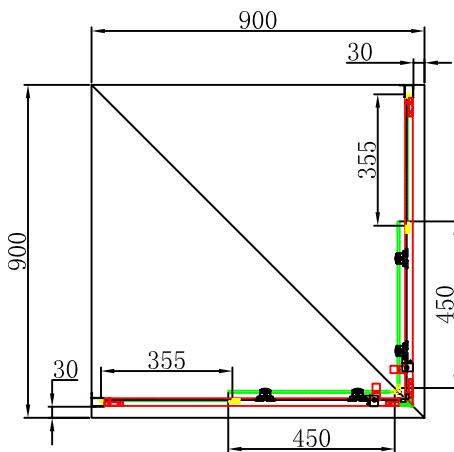
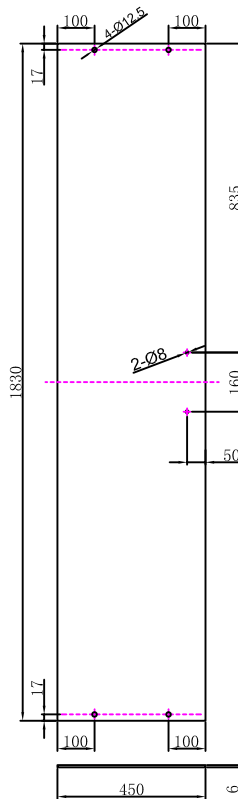
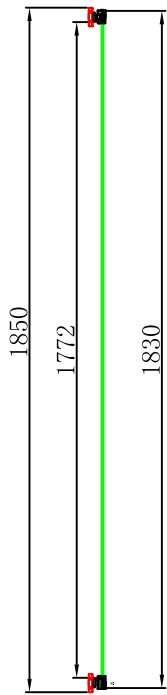

$$(870-890) * (870-890) * 1850$$

CX10070

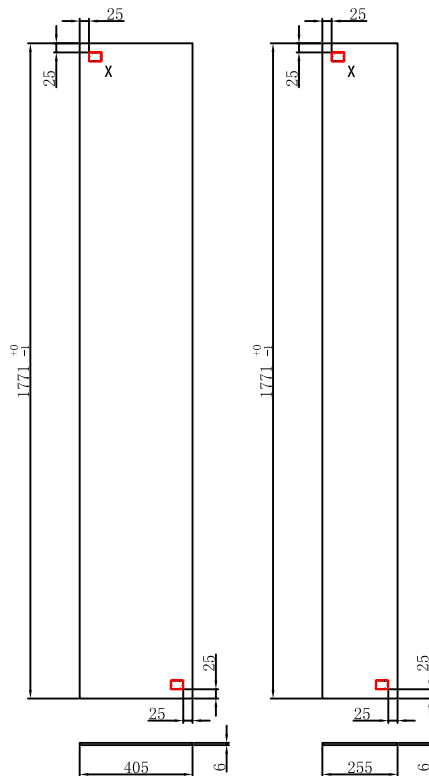
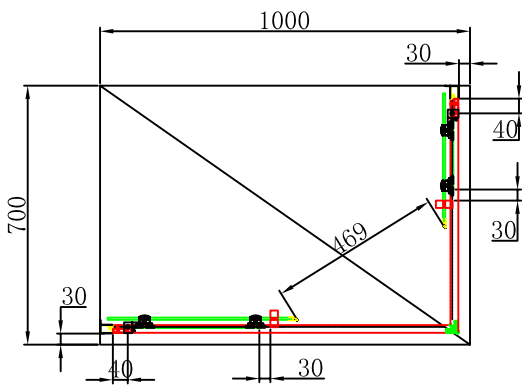
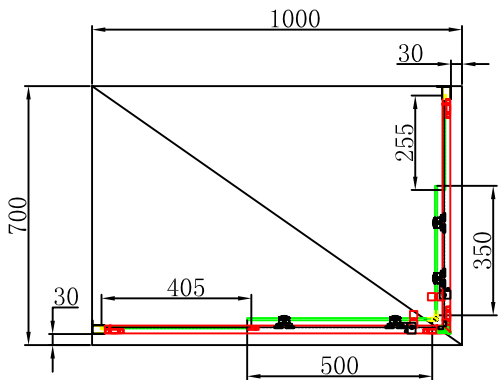
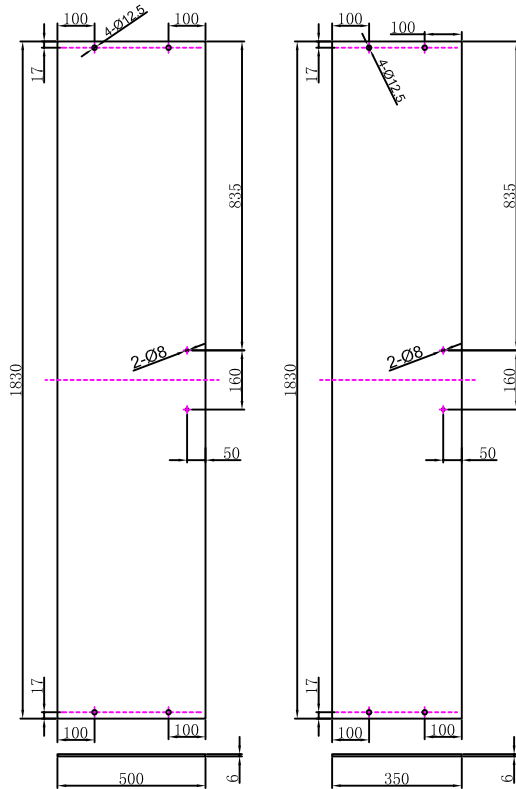
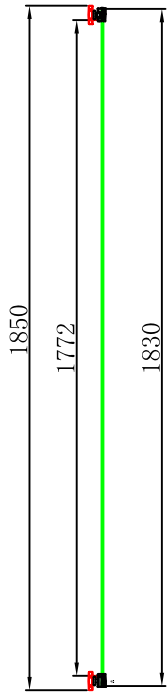

Tempered
Glass 34x24

$(670-690) * (970-990) * 1850$

CX12070

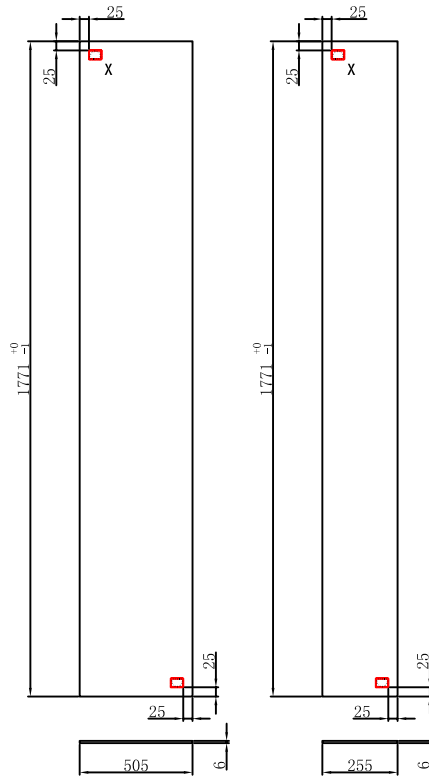
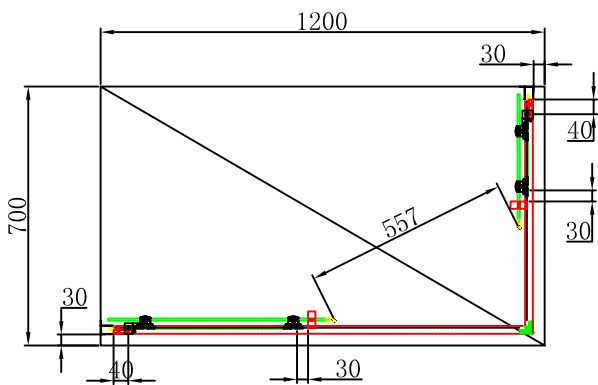
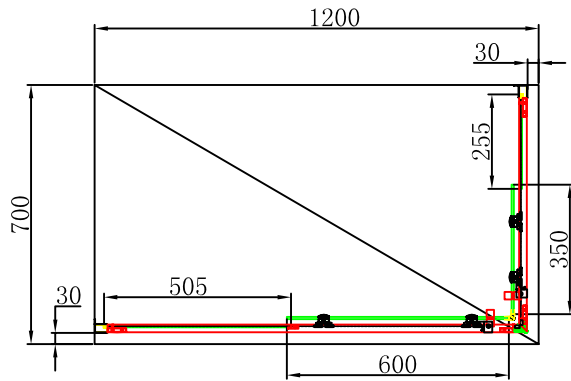
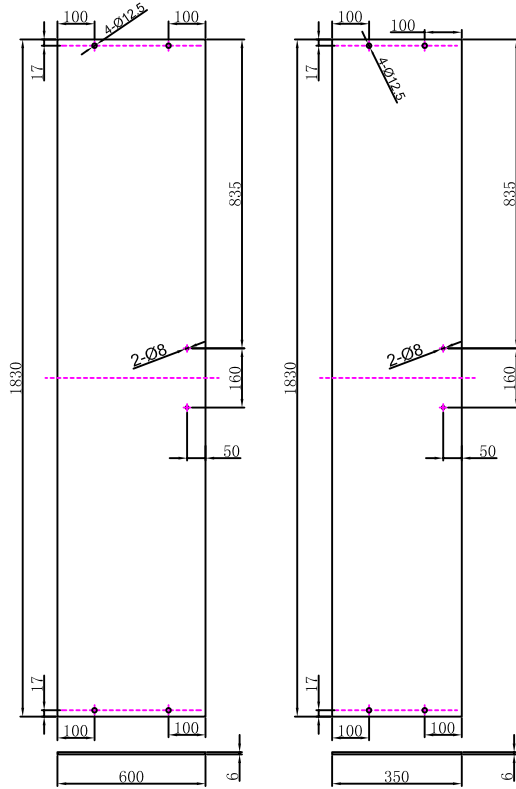
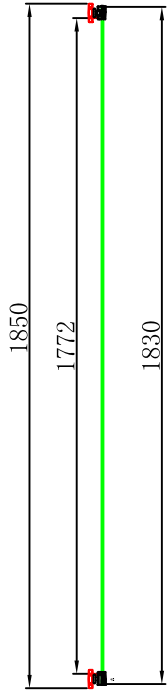

Tempered
Glass 34x24

$(670-690) * (1170-1190) * 1850$

CX7290

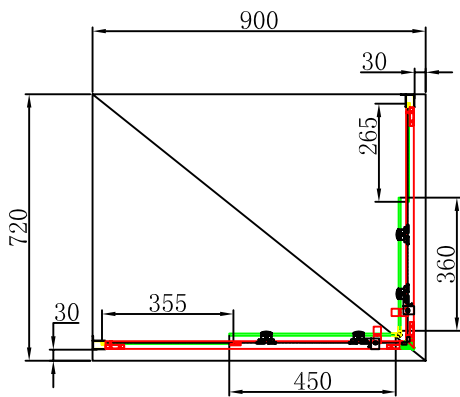
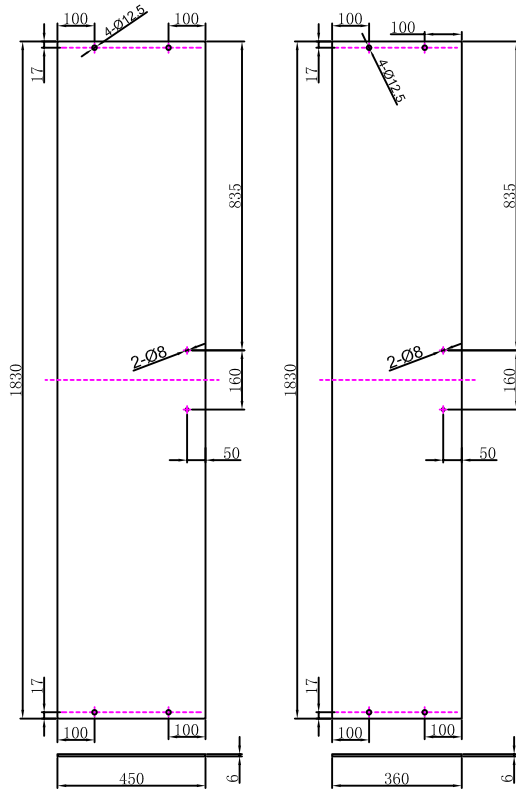
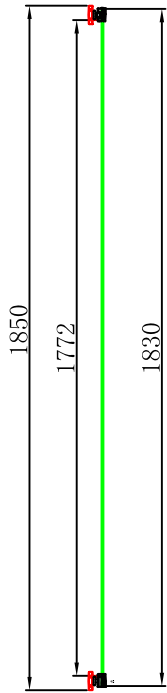

Tempered
Glass 34x24

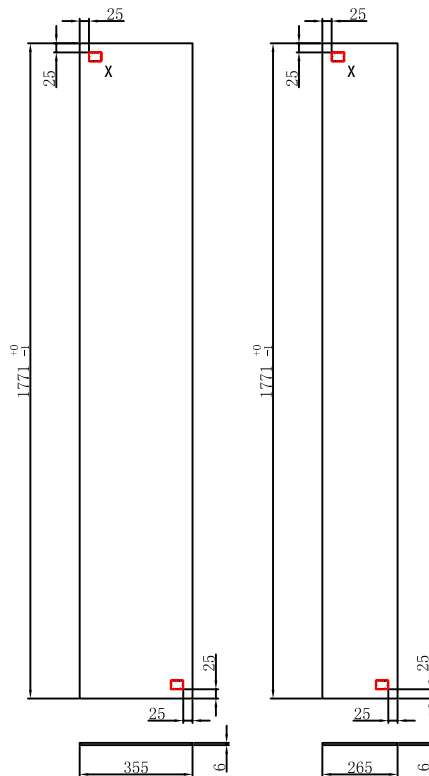
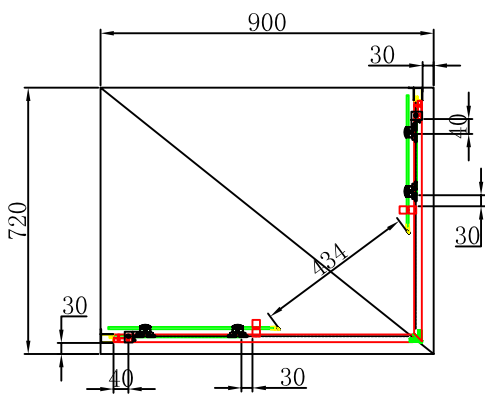

(690-710) * (870-890) * 1850

CX10080

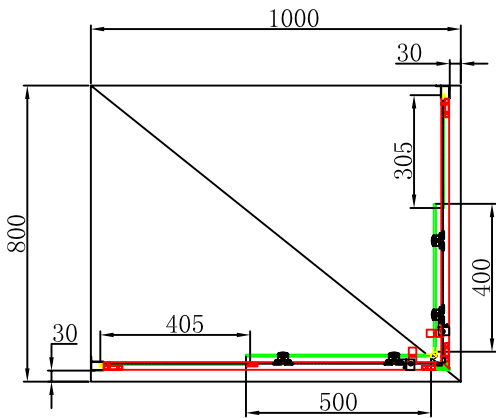
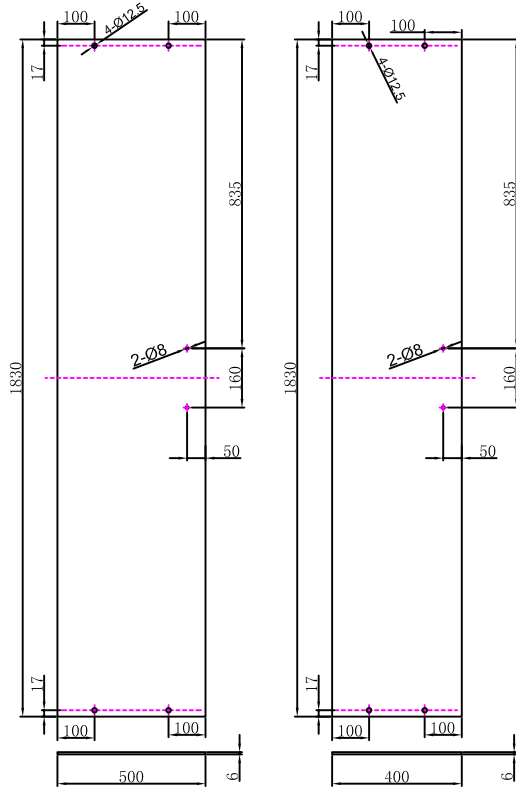
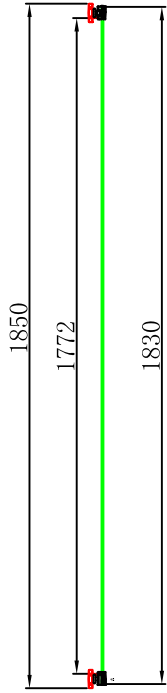

Tempered
Glass 34x24

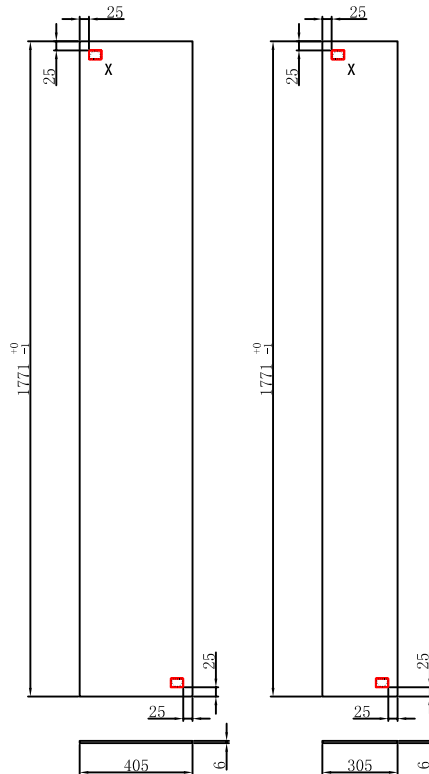
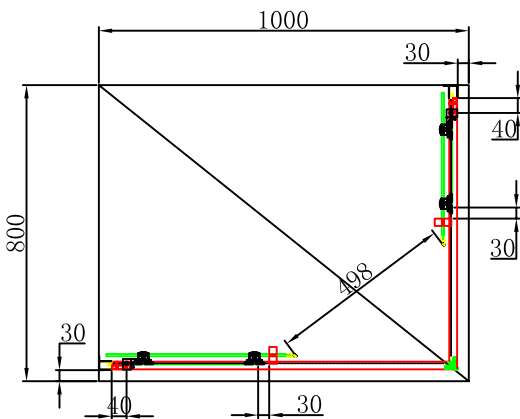

(770-790) * (970-990) * 1850

CX12080

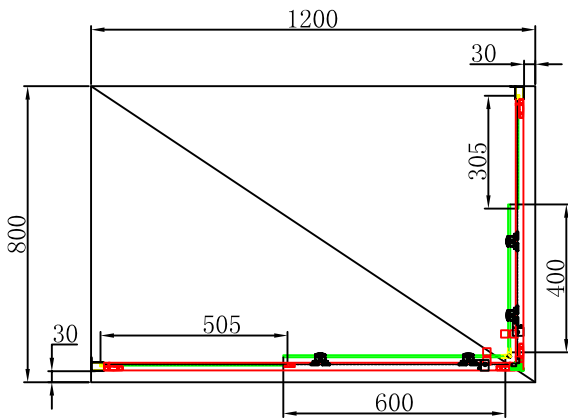
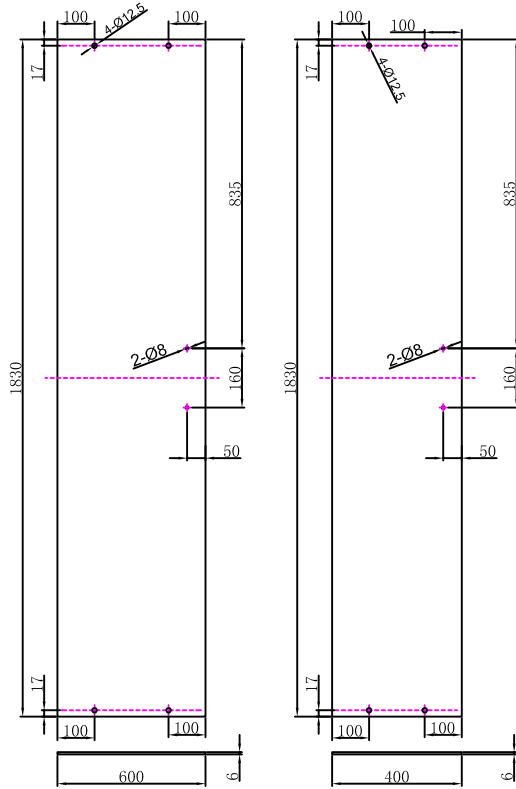
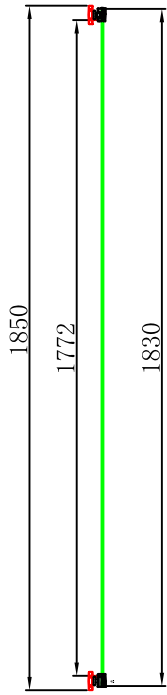

Tempered
Glass 34x24

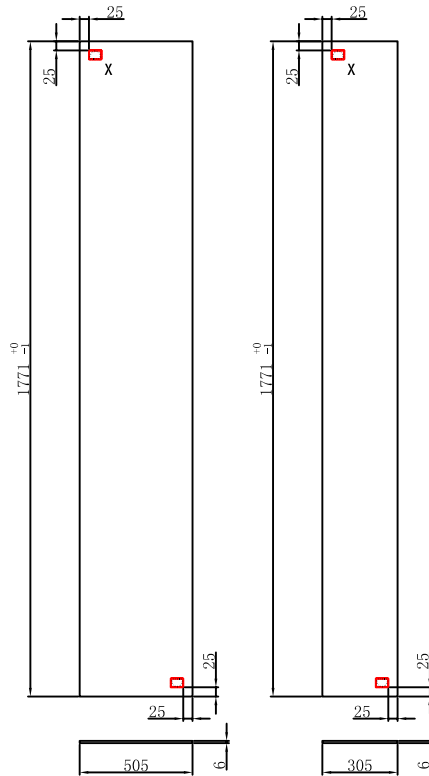
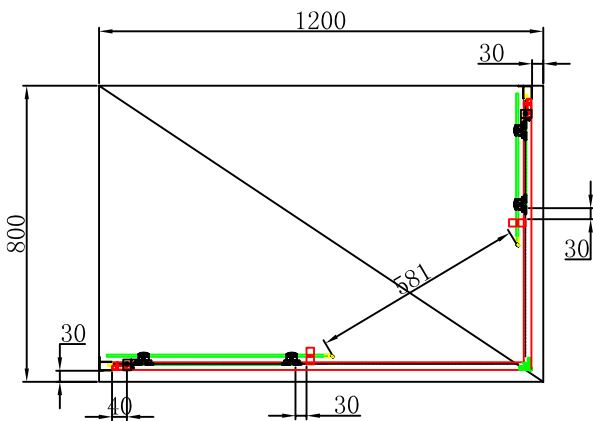

(770-790) * (1170-1190) * 1850

HCX140

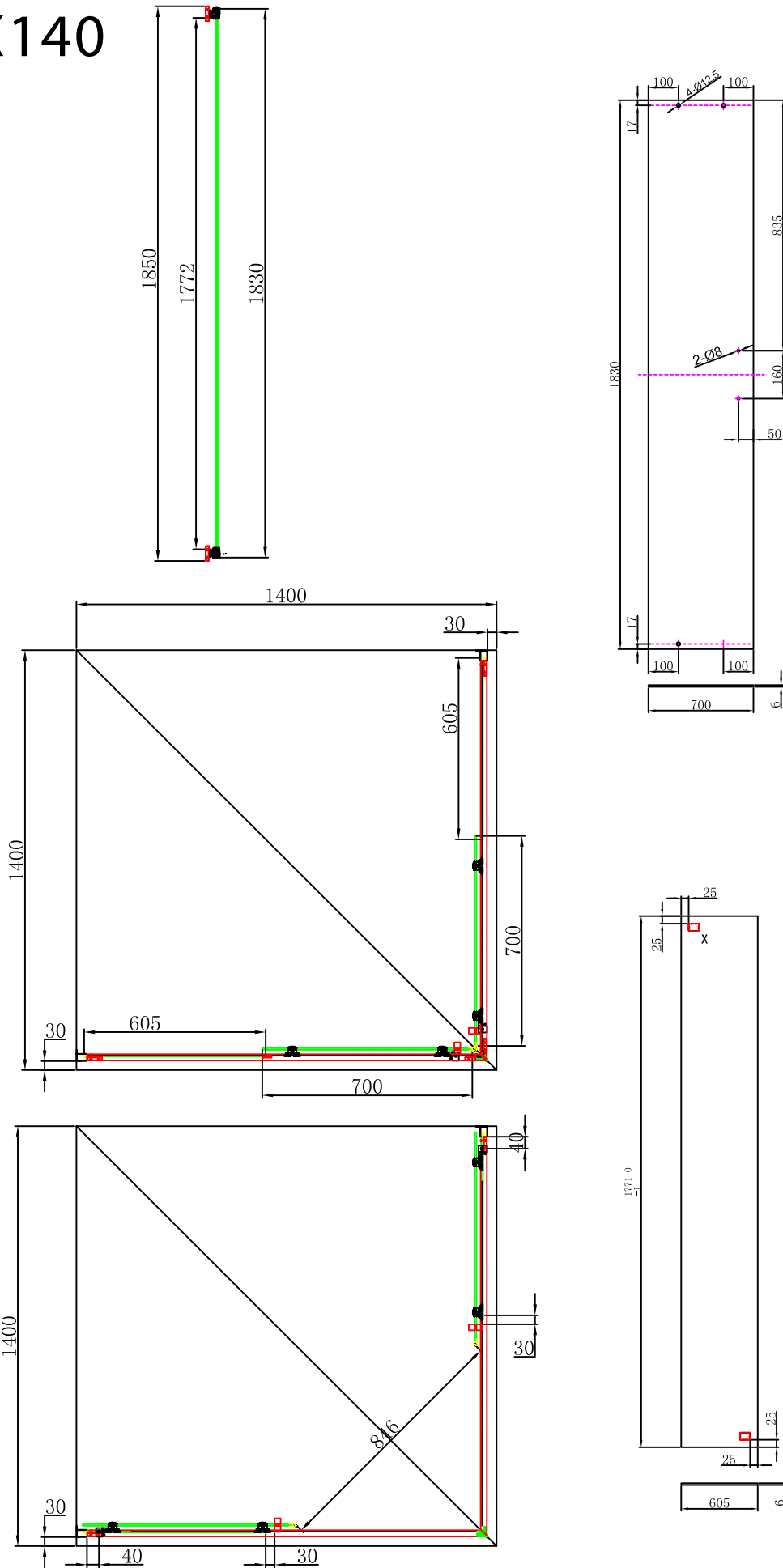

(1370 - 1390) * 1850

HCX130

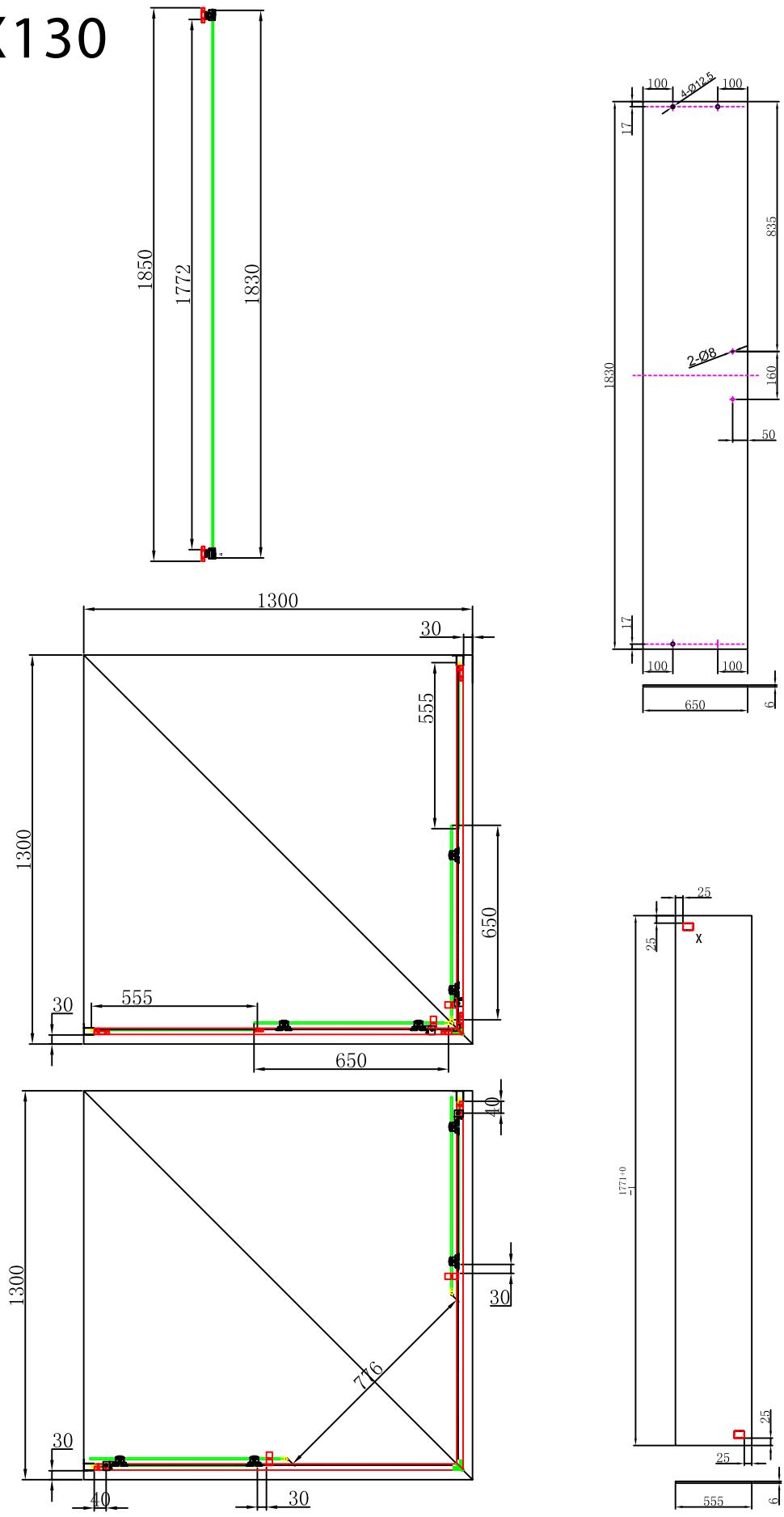

(1270-1290) * 1850

HCX110

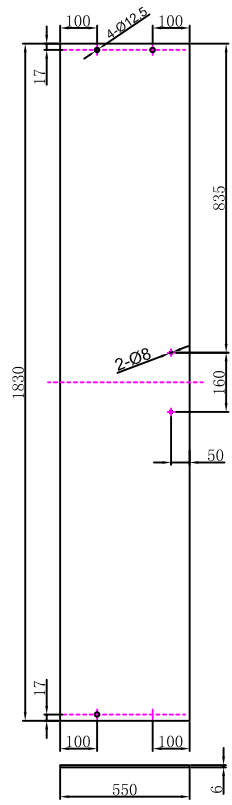
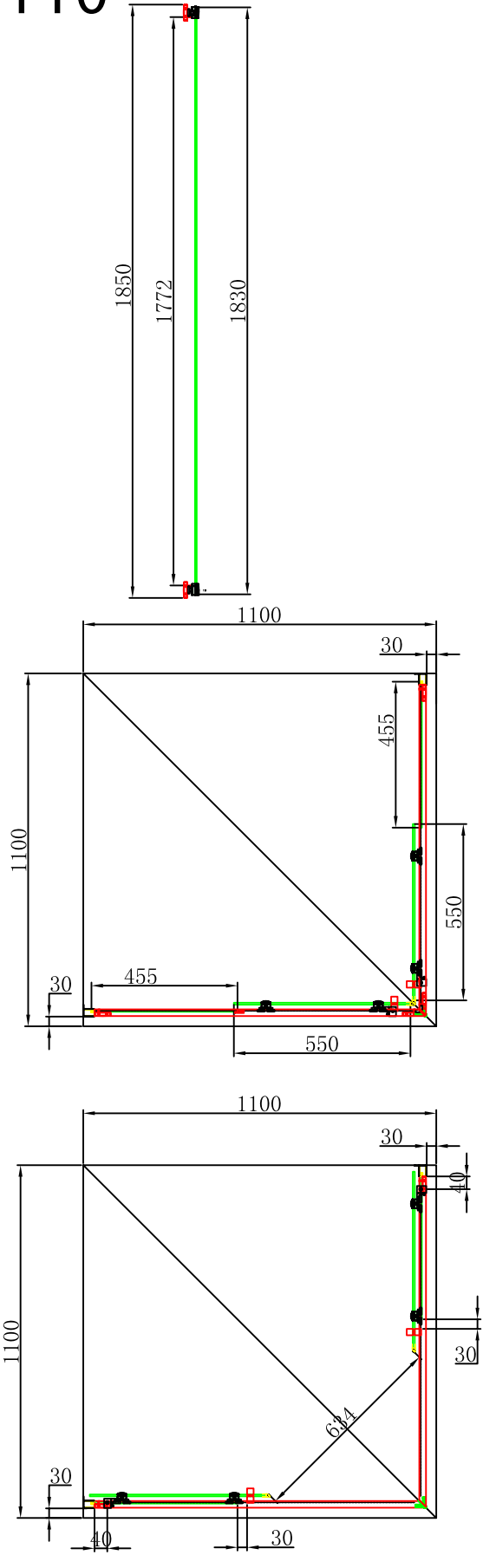

技术要求:
 1. 两直边不直度允差1.0mm。
 2. 玻璃扭曲允差2mm。
 3. 四周精磨干边。

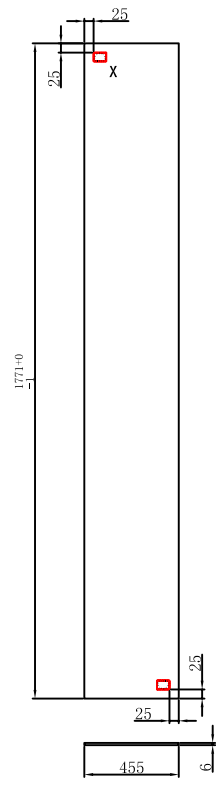

Tempered
Glass

(1070-1090) * 1850

HCX80

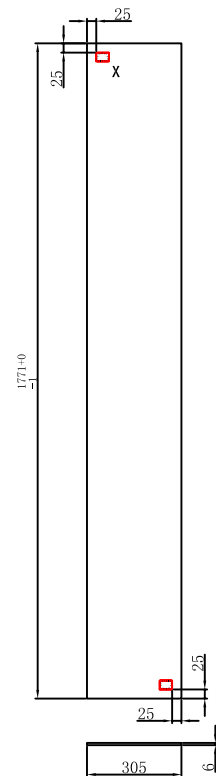
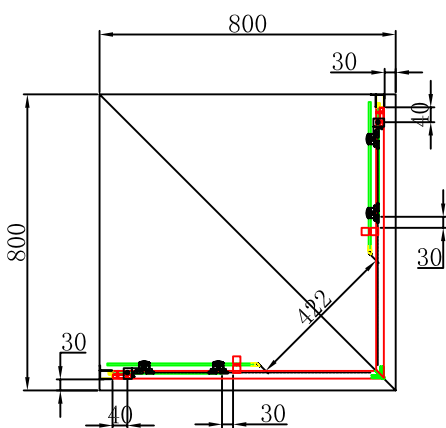
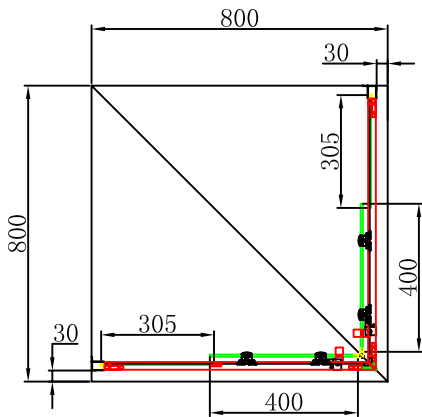
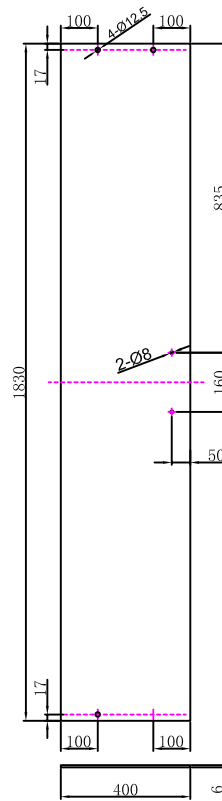
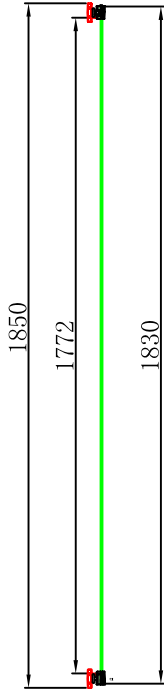

Tempered
Glass
X处 5:1

(770-790) * 1850

HCX70

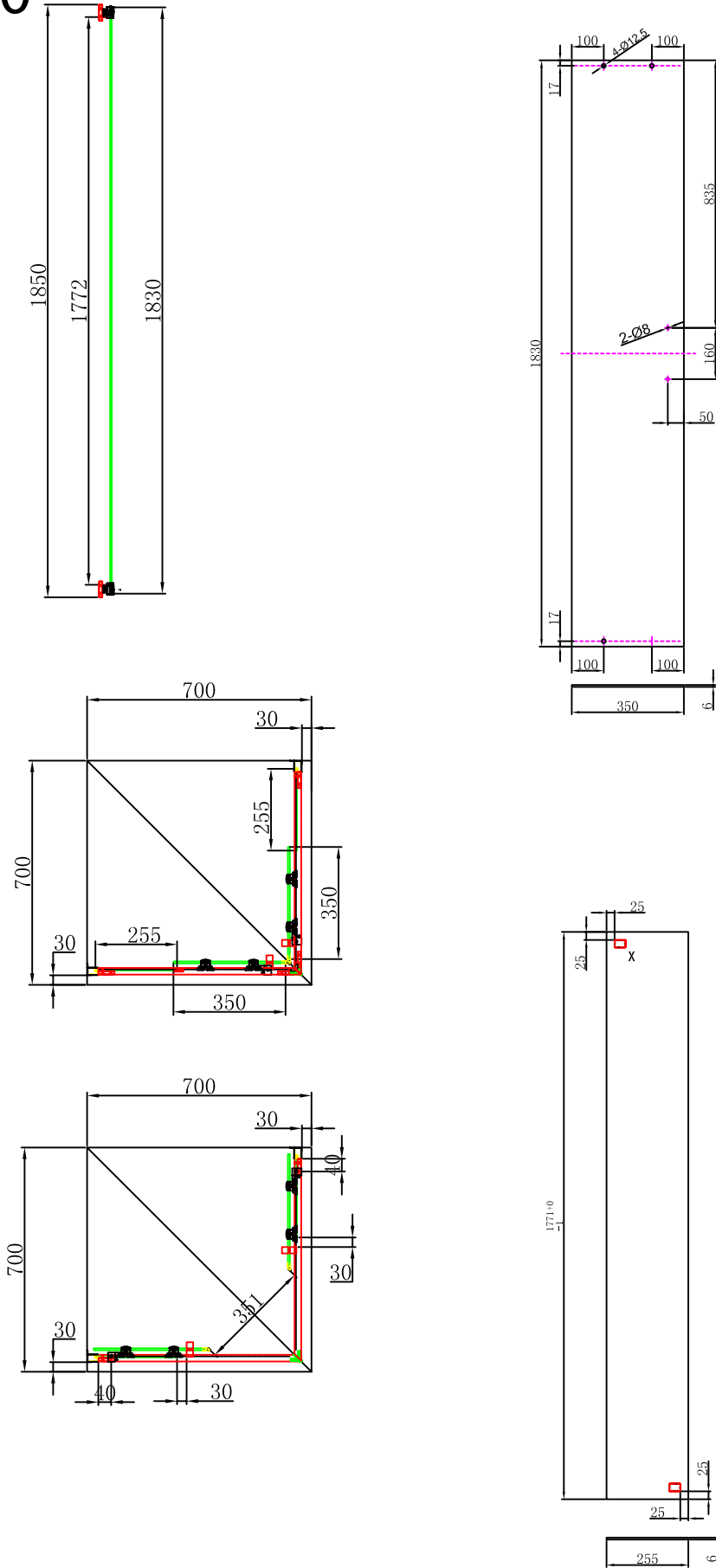

Tempered
Glass

(670-690) * 1850